

# Data Sheet

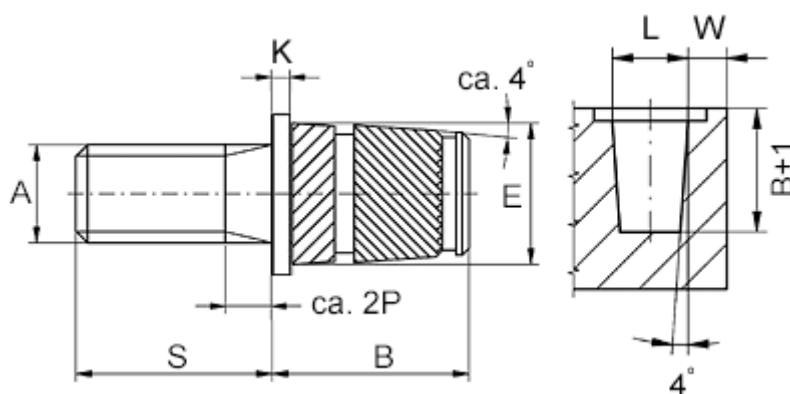

Article number: 12859100040860  
Description: KLEE-coil 859 100 040.860  
M4 Brass

## Measures



Flange diameter E1	= 8.0
Flange height	= 0.8
Male thread A	= M4x0,7
Min distance to edge W	= 2.0
Mounting length B	= 8.3
Outer diameter E	= 6.0
Pin length S	= 16
Recommended bore diameter W +0.1	= 5.8